

Test Data Sheet

PM-Sr_2.1M3

S/N:

Resonant electro-optic phase modulator
 with
 - tunable resonance frequency
 - thermal crystal mount

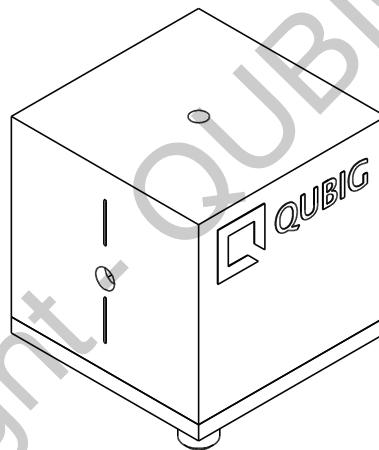

RF properties	Value	Unit
Resonance frequency: f_0 ¹⁾	1977 - 2095	GHz
Preset frequency: f_{set} ¹⁾	2036	MHz
Bandwidth: $\Delta\nu$	5.1	MHz
Quality factor: Q	399	
Required RF power for 1rad @ 461 689nm ²⁾	25.2 29.7	dBm
max. RF power: RF_{max} ³⁾	2	W

Optical properties		
Aperture	3x3	mm ²
Wavefront distortion (633nm)	$\lambda/6$	nm
Max. optical intensity (461 689nm)	≤ 0.1 ≤ 2	W/mm ²
AR coating ($R_{avg} < 0.5\%$)	360 - 650 630 - 1100	nm

¹⁾ at 21°C ²⁾ with 50Ω termination ³⁾ no damage with $RF_{in} < 3W$

Measured modulation

Fig. 1: Oscilloscope trace

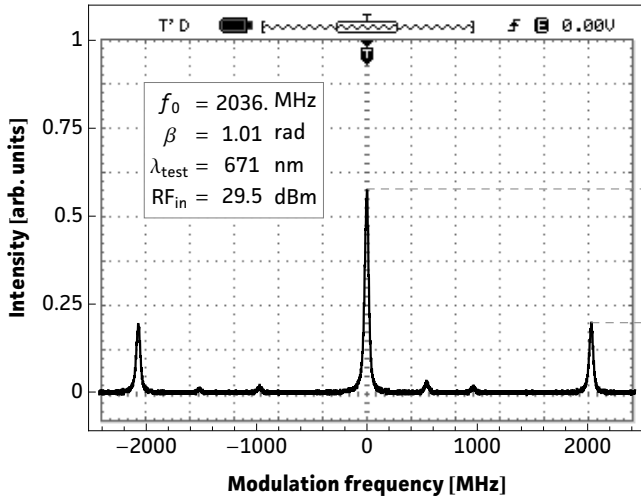

Fig. 2: Carrier/sideband ratio

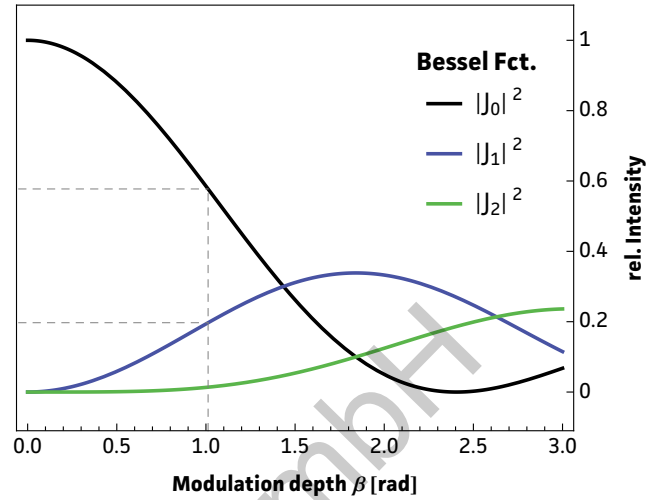

Table 1: Expected modulation

$\beta = 1$ rad	unit	λ_1	λ_2	λ_3
λ	nm	461	671	689
P	dBm	25.2	29.4	29.7
P	mW	334	870	925
U	V _p	5.8	9.3	9.6
U _{π}	V _p	18.2	29.3	30.2
β / U	rad / V	0.17	0.11	0.1

Fig.1: Recorded oscilloscope trace retrieved from a test setup as illustrated below.

Fig.2: Squared absolute values of first-kind Bessel functions vs. modulation depth. Vertical lines reveal the ratio between the carrier $|J_0|^2$ and the i^{th} sideband $|J_i|^2$ at a specific β .

Fig.3: Dependency between RF amplitude and modulation depth for different wavelengths. Points on the curve allow to retrieve either the required RF amplitude for a specific/desired β or the max. achievable modulation depth for a given/available RF power.

Table 1: Expected RF-amplitude/-power values and conversion factors for the required wavelength at the reference modulation depth of 1 rad. **Note:** Experimentally recorded modulation depth displayed in Fig.1 might vary from the respective values ($\beta=1$ rad) provided in the table.

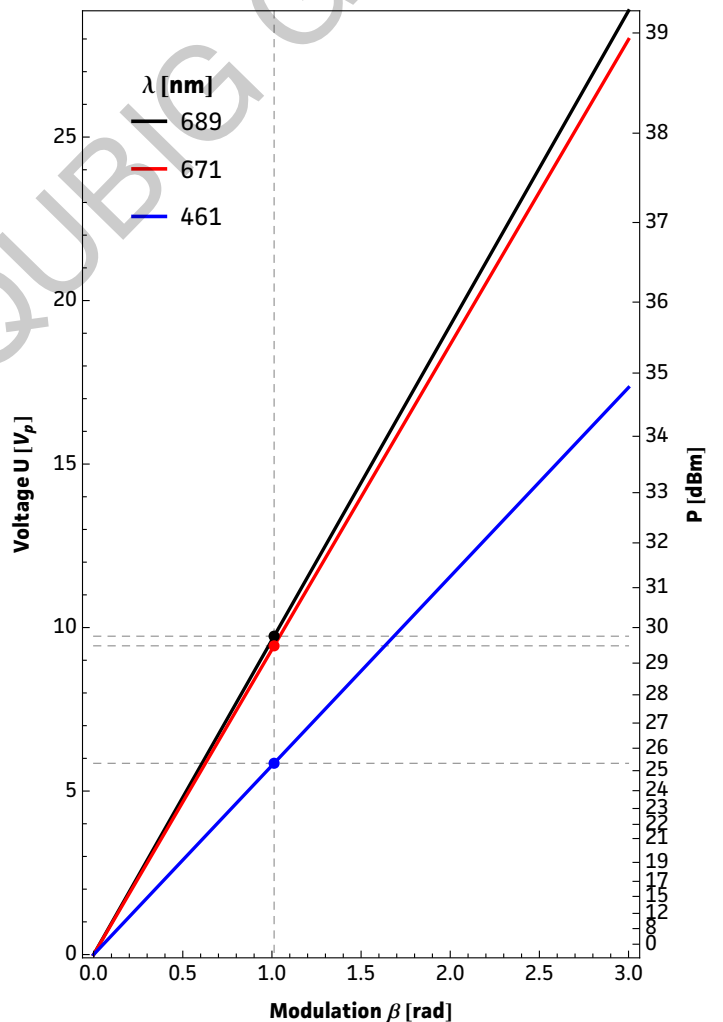
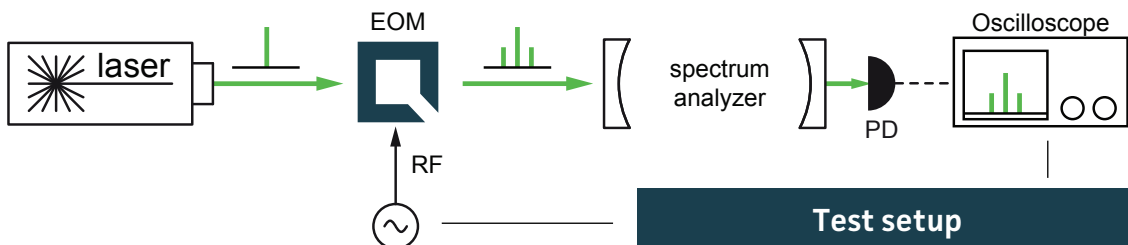
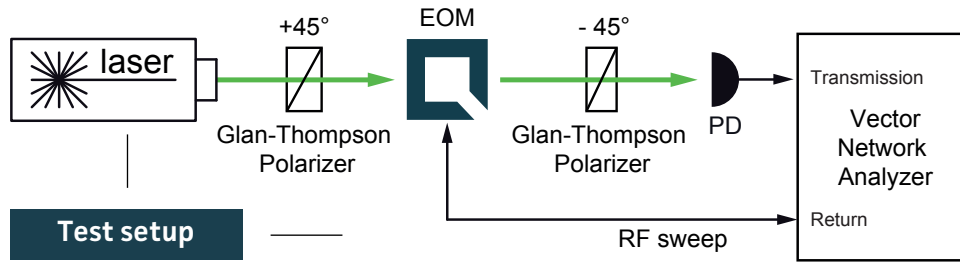

Fig. 3: RF-signal amplitude vs. modulation depth



Resonance characteristics



12/3/2018 7:20:18 PM
1328.5170K92-100178-XI

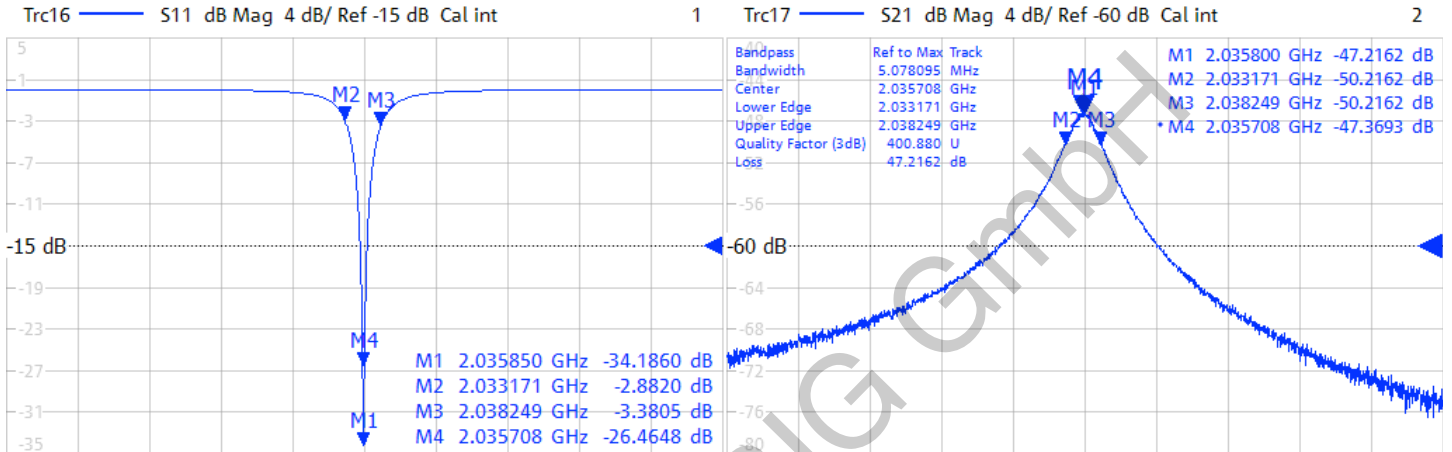

Ch1 Center 2.036 GHz Pwr 3 dBm Bw 10 kHz Span 100 MHz Ch1 Center 2.036 GHz Pwr 3 dBm Bw 10 kHz Span 100 MHz

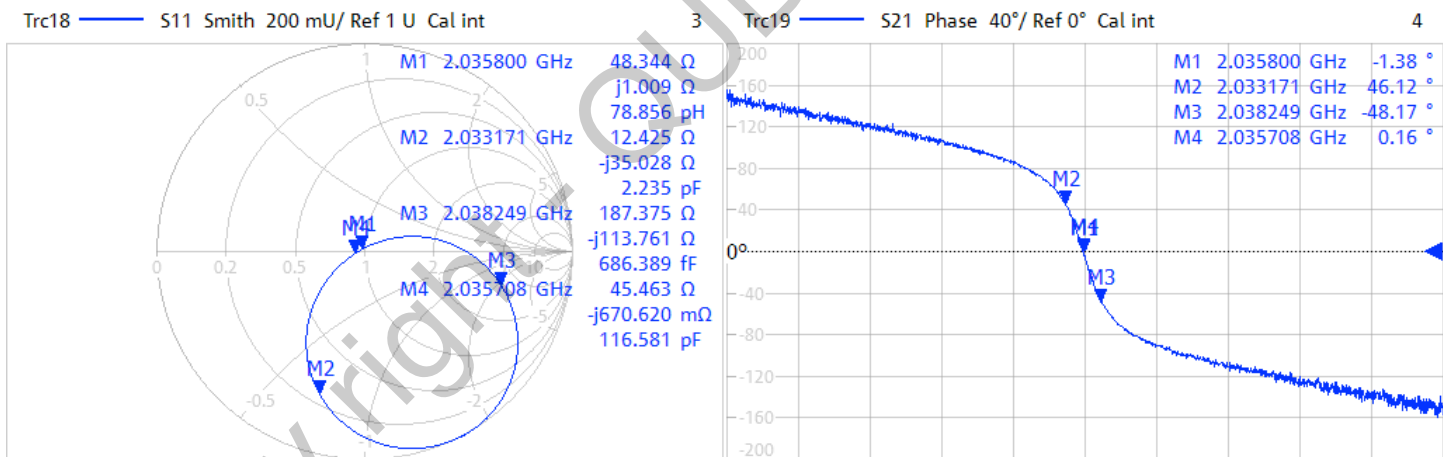

Ch1 Center 2.036 GHz Pwr 3 dBm Bw 10 kHz Span 100 MHz Ch1 Center 2.036 GHz Pwr 3 dBm Bw 10 kHz Span 100 MHz

Tuning performance

MAX resonance frequency	$f_0 \text{ max}$	2095	MHz
MIN resonance frequency	$f_0 \text{ min}$	1977	MHz
number of turns	N_{max}	5	
counter clock-wise turns ↻		higher f_0 ↑	
clock-wise turns ↻		lower f_0 ↓	

- use only supplied tuning tool
- actuate tuner carefully
- do not apply too much pressure or torque
- keep tuning tool coaxial
- tuner might not be perfectly orthogonal to box

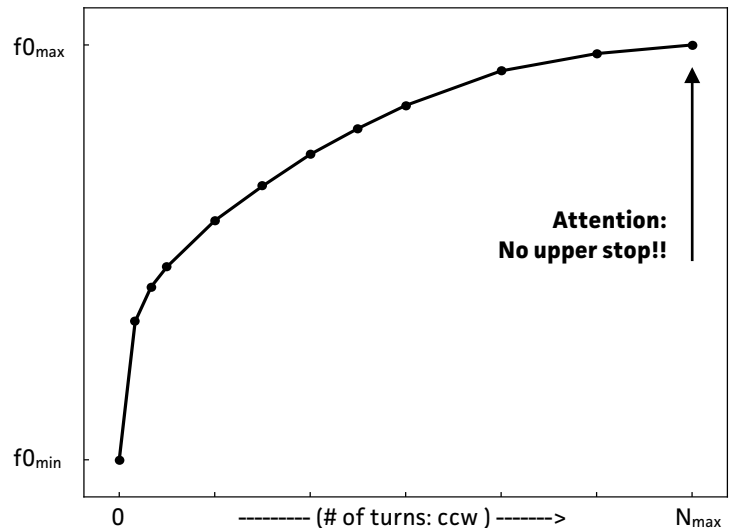

Handling instructions

- Input laser polarization must be aligned with respect to the white markers on the housing
- Please handle device carefully. Avoid shock. Don't drop.
- After turn on the resonance frequency might drift slightly with applied RF power. Please compensate by tuning the RF drive frequency until steady-state (~min).

Package drawing

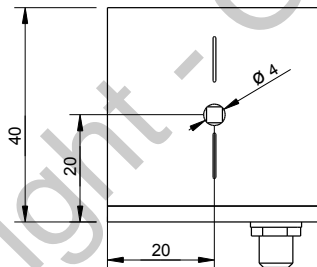
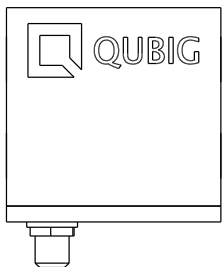
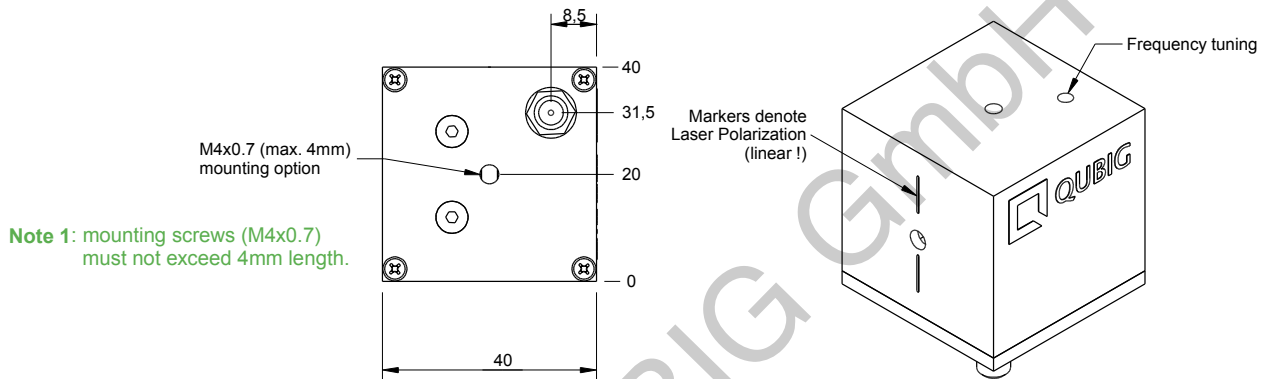

Note 2: crystal aperture is 3x3mm.

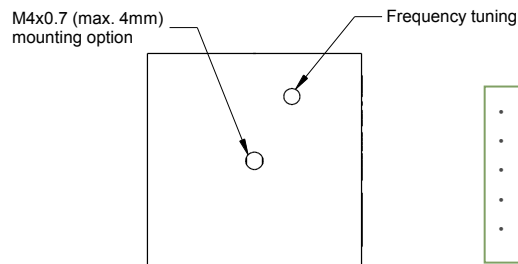
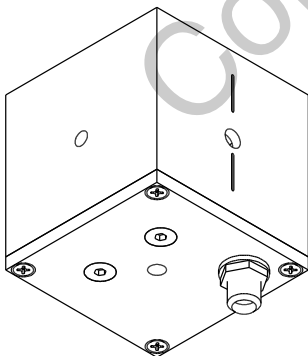
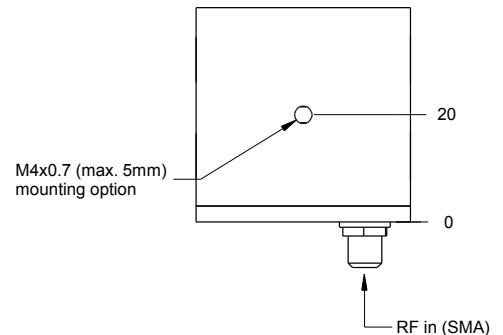

Attention!!

- use only supplied tuning tool
- actuate tuner carefully
- do not apply too much pressure or torque
- keep tuning tool coaxial
- tuner might not be perfectly orthogonal to box

Tested by:

Tel: +49 89 2302 9101
 Fax: +49 89 2302 9102
 eMail: mail@qubig.com
 web: www.qubig.com

Qubig GmbH
 Balanstr. 57
 81541 Munich
 Germany