

Test Data Sheet

PM10 - NIR

S/N:

Resonant electro-optic phase modulator

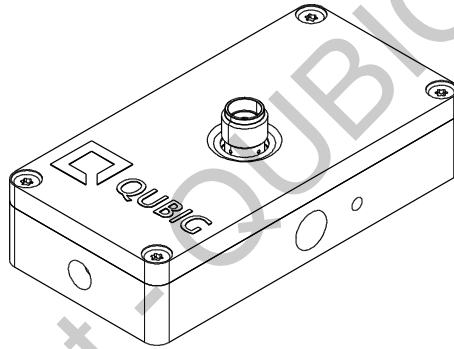

RF properties	Value	Unit
Resonance frequency: f_0 ¹⁾	9740 - 9885	MHz
Preset frequency: f_{set} ¹⁾	9775	MHz
Bandwidth: $\Delta\nu$	64.6	MHz
Quality factor Q	151	
Required RF power for 1 rad @ 1064 nm	39.2	dBm
max. RF power: RF_{max} ²⁾	5	W

Optical properties		
EO crystal	KTP	
Aperture	∅ 2	mm
Wavefront distortion (@ 633 nm)	$\lambda/8$	
recommended max. optical intensity (@ 1064nm)	20	W/mm ²
AR coating ($R_{avg} < 1\%$)	780 - 1560	nm

¹⁾ at 27.7 °C ²⁾ no damage with $RF_{in} < 10W$, but use of a proper heatsink is strongly recommended at high powers

Fig. 1: Oscilloscope trace

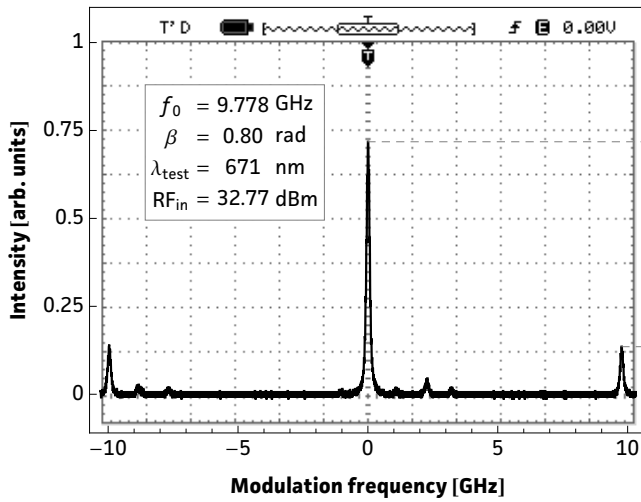

Fig. 2: Carrier/sideband ratio

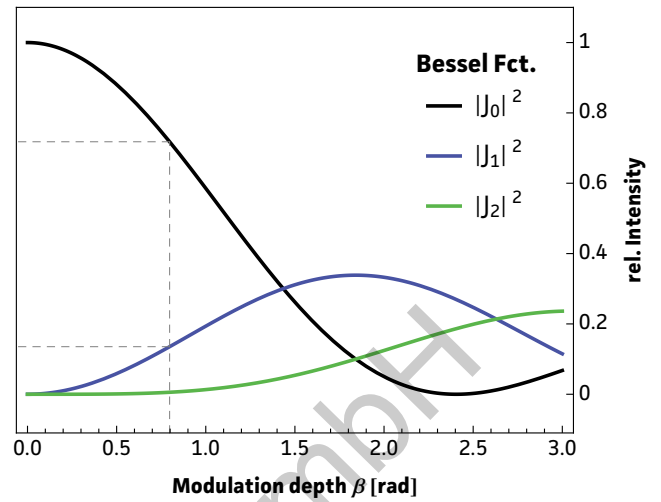

Table 1: Expected modulation

$\beta = 1 \text{ rad}$	unit	λ_1	λ_2
λ	nm	671	1064
P	dBm	34.7	39.2
P	W	2.98	8.23
U	V _p	17.2	28.7
U _{π}	V _p	54.2	90.1
β/U	rad/V	0.06	0.03

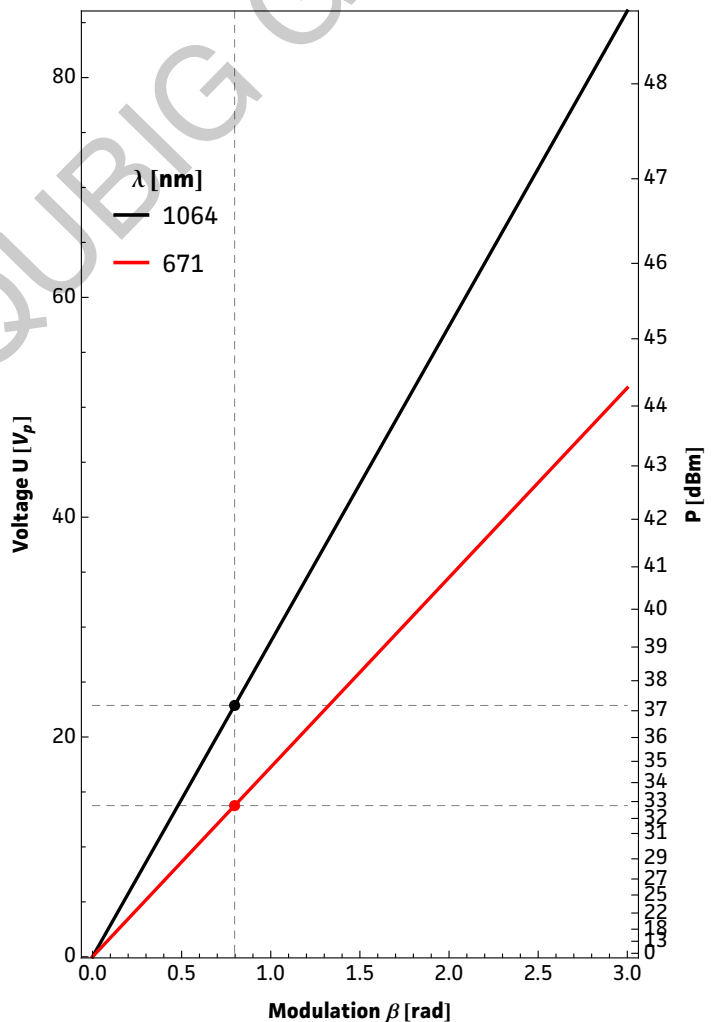

Fig. 1: Recorded oscilloscope trace retrieved from a test setup as illustrated below.

Fig. 2: Squared absolute values of first-kind Bessel functions vs. modulation depth. Vertical lines reveal the ratio between the carrier $|J_0|^2$ and the i^{th} sideband $|J_i|^2$ at a specific β .

Fig. 3: Dependency between RF amplitude and modulation depth for different wavelengths. Points on the curve allow to retrieve either the required RF amplitude for a specific/desired β or the max. achievable modulation depth for a given/available RF power.

Table 1: Expected RF-amplitude/-power values and conversion factors for the required wavelength at the reference modulation depth of 1 rad. **Note:** Experimentally recorded modulation depth displayed in Fig. 1 might vary from the respective values ($\beta=1\text{rad}$) provided in the table.

Fig. 3: RF-signal amplitude vs. modulation depth

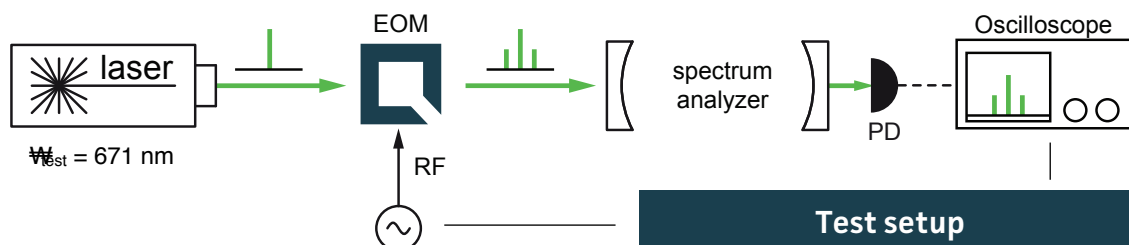

Resonance characteristics

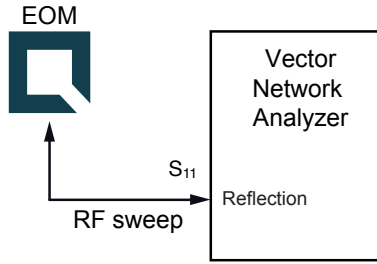

4/24/2018 4:44:24 PM
1311.6010K62-101870-Bu $T_{EOM} = 26.7\text{ }^{\circ}\text{C}$

Trc1 — S11 dB Mag 5 dB/ Ref 0 dB Cal Trc2 — S11 Smith 200 mU/ Ref 1 U Cal

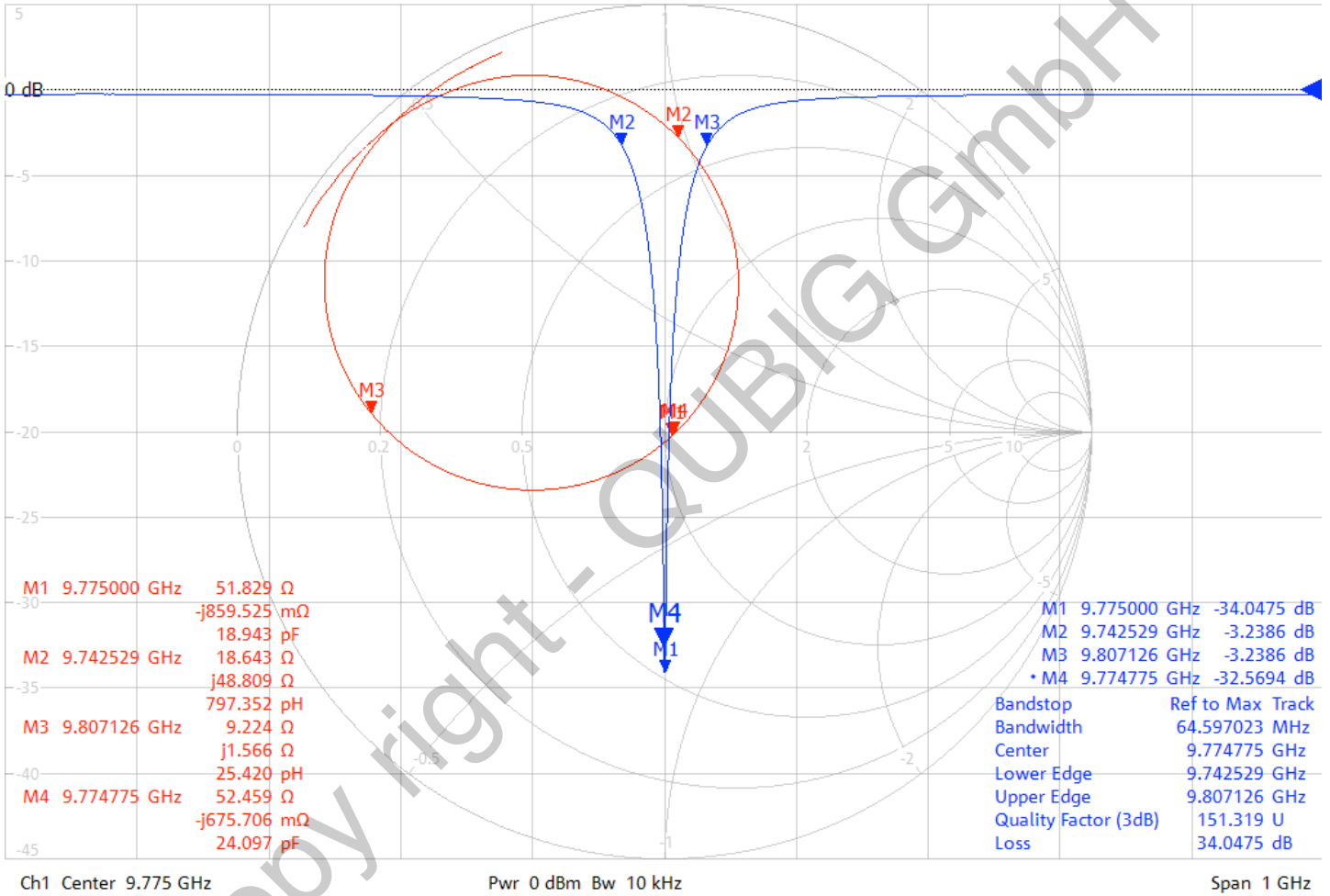

Frequency tuning performance @ $T=23.8^{\circ}\text{C}$

MAX resonance frequency	$f_{0,max}$	9885	MHz
MIN resonance frequency	$f_{0,min}$	9740	MHz
number of turns	N_{max}	9	
tuning range		145	MHz
temperature dependence	df_0/dT	-3.4	MHz/ $^{\circ}\text{C}$

- only use supplied tuning tool
- actuate tuner carefully / do not apply too much torque, especially close to $f_{0,max}$
- there might be no hard upper or lower stops (!)

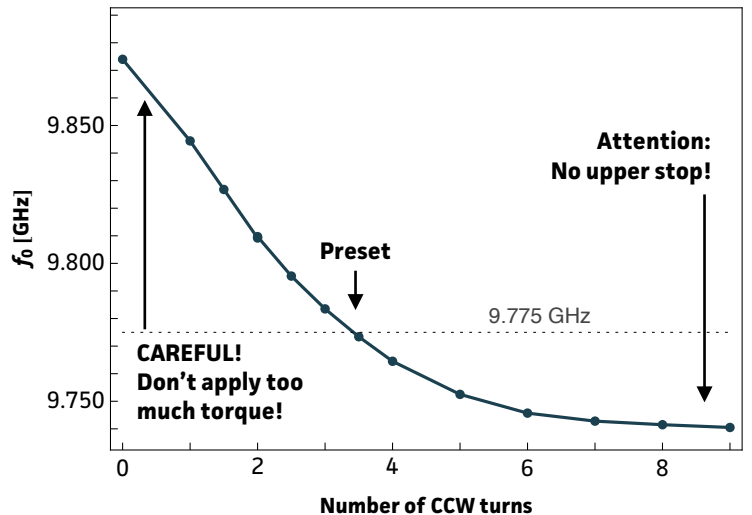

Package drawing

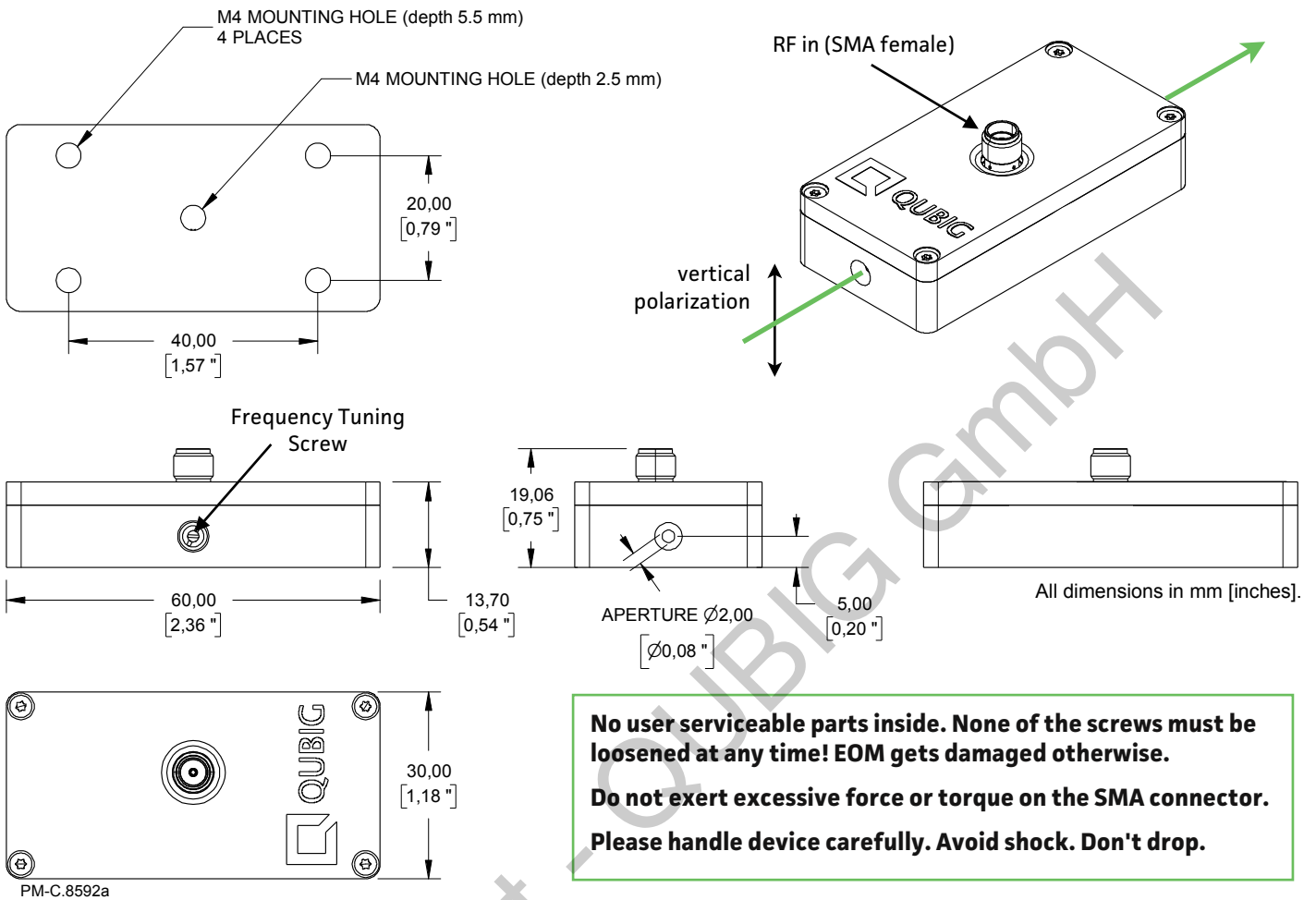

Tested by:

Tel: +49 89 2302 9101
Fax: +49 89 2302 9102
eMail: mail@qubig.com
web: www.qubig.com

Qubig GmbH
Balanstr. 57
81451 Munich
Germany